

Specification :-

1. High Flow Manifold Double Meter Oxygen Regulator (AOX-14)
2. Inlet Pressure :- (0-400 Bar)
3. Outlet / Working Pressure :- (0-14 Bar)
4. Safety Pressure :- (15 Bar)
5. Outlet Connection:- 3/8" - 19 BSP(RH)

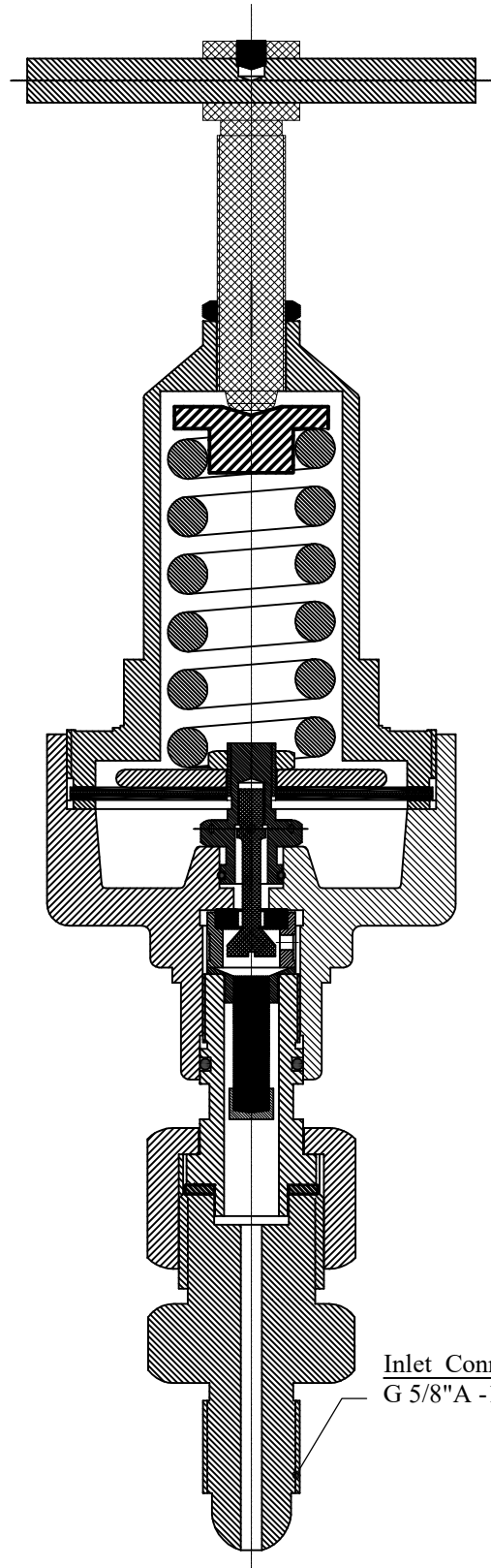
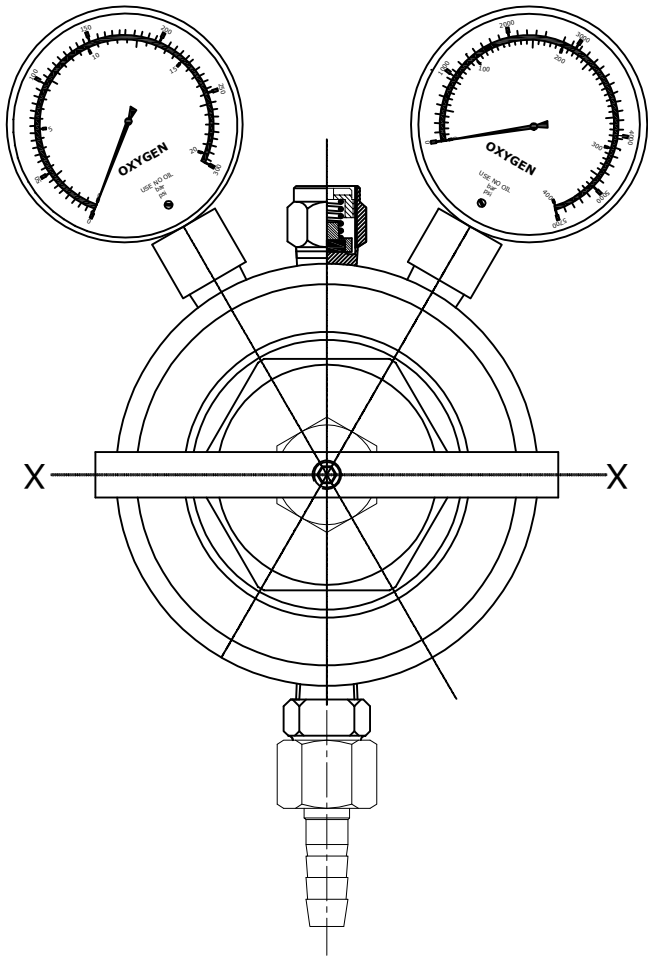

Inlet Connection (Oxygen)
G 5/8"A -14 TPI (RH)